



Population Health Colloquium & Medical Home Summit

March 23 - 25, 2015

Loews Hotel, Philadelphia, PA

Table of Contents

Page Name	Page #
Table of Contents	1
Event Information	2
Event Rules and Regulations	3
Union Rules and Jurisdictions	4
Terms and Conditions	5
Method of Payment	6
Third Party Billing Authorization	7
Exhibitor Appointed Contractor	8
Standard and Premium Packages	9
Platinum Booth Packages	10
Posh Booth Packages	11
Rental Booths	12
Carpet, Padding, and Cleaning Services	13
Upscale Flooring Options	14
Booth Furnishings	15
Floral and Booth Accessories	16
Installation and Dismantle Labor	17
Pinnacle-Supervised Labor Information Sheet	18
Submitting Artwork Guidelines	19
Graphics Order Form	20
Poster Printing Services	21
Material Handling Rates and Worksheet	22
OUTBOUND Shipping Label and Bill of Lading Request	23
Advanced Warehouse Shipping Labels	24
Direct to Showsite Shipping Labels	25
Order Recap	26



Discount Deadline: March 9

Event Information

Population Health Colloquium & Medical Home Summit

March 23 - 25, 2015

Event Schedule

Exhibitor move in	Monday, March 23	9:00 a.m. - 11:45 a.m
Exhibit hours	Monday, March 23	12:00 pm - 6:30 pm
Exhibit hours	Tuesday, March 24	7:00 am - 6:30 pm
Exhibit hours	Wednesday, March 25	7:00 am - 10:30 am
Exhibitor move out	Wednesday, March 25	10:30 a.m. - 12:00 p.m.

Important Dates

Exhibitor Appointed Contractor deadline:	Monday, March 9	5:00 PM
Discount deadline for all Pinnacle orders:	Monday, March 9	5:00 PM
Discount deadline for custom furnishings orders:	Monday, March 9	5:00 PM
Advanced warehouse opens:	Monday, March 9	8:00 am - 3:00 pm daily
Advanced warehouse closes:	Thursday, March 19	8:00 am - 3:00 pm daily
Show site delivery timeframe:	Monday, March 23	Between 8:00 am - 10:00 am

Included In Your Booth Space

Each exhibitors booth space includes: 6' Skirted Table, 2 chairs, 1 waste basket

To order furnishings for your booth, please see the attached pages.

Or order online at www.pinnacle-expo.com

Standard dimanesions: 8'x10'

Event drape colors: Black

Exhibit hall carpet: Standard Ballroom Carpeting

Shipping Information

Advanced Warehouse

Population Health Colloquium
Pinnacle Exposition Services
(Company Name and Booth Number)
C/O Cargo Solutions-Eagle Trucking
900 CALCON HOOK RD
SHARON HILL, PA 19079

Show Site Deliveries

Population Health Colloquium
Pinnacle Exposition Services
(Company Name and Booth Number)
C/O Loews Hotel Philadelphia
1200 Market Street
Philadelphia, PA 19107

Event Rules and Regulations

1. Each exhibitor agrees to maintain decorum in and around his exhibit space that will not obstruct nor disturb other exhibitors. The aisles, passageways, overhead spaces, public meeting rooms, and other meeting facilities are controlled by show management. Each exhibitor will adhere to the following space allocation restrictions as determined by show management:

- a) No obstructive booth design is permitted. The exhibitor is not allowed to obstruct the view, interfere with or adversely affect the displays of other exhibitors.
- b) **Side panels may not be more than 4' high**
- c) **Maximum booth height for 10'x10', 8'x10', 10'x20', 8'x20' and any other booth size is 8 feet high**
- d) Exhibitors may not place any display material, demonstrations, or exhibits, nor extend their stand structures and fittings, beyond their contracted boundary.
- e) No interference with lighting of space of exhibitors will be allowed.
- f) Signs, banners, and posters may not be placed outside the exhibit space assigned to each exhibitor.
- g) Entrances to booths must be in the direction indicated on the floor plan.

2. Exhibitors may not sublet, assign, or share any part of the booth space allocated

3. Absolutely no dismantling/tear-down of booths will be permitted before the specified break down times.

4. All exhibitors are responsible for making their own arrangements for services.

- a) Electrical, telecommunication, and AV services are not included in any Sponsor or Exhibitor Package.

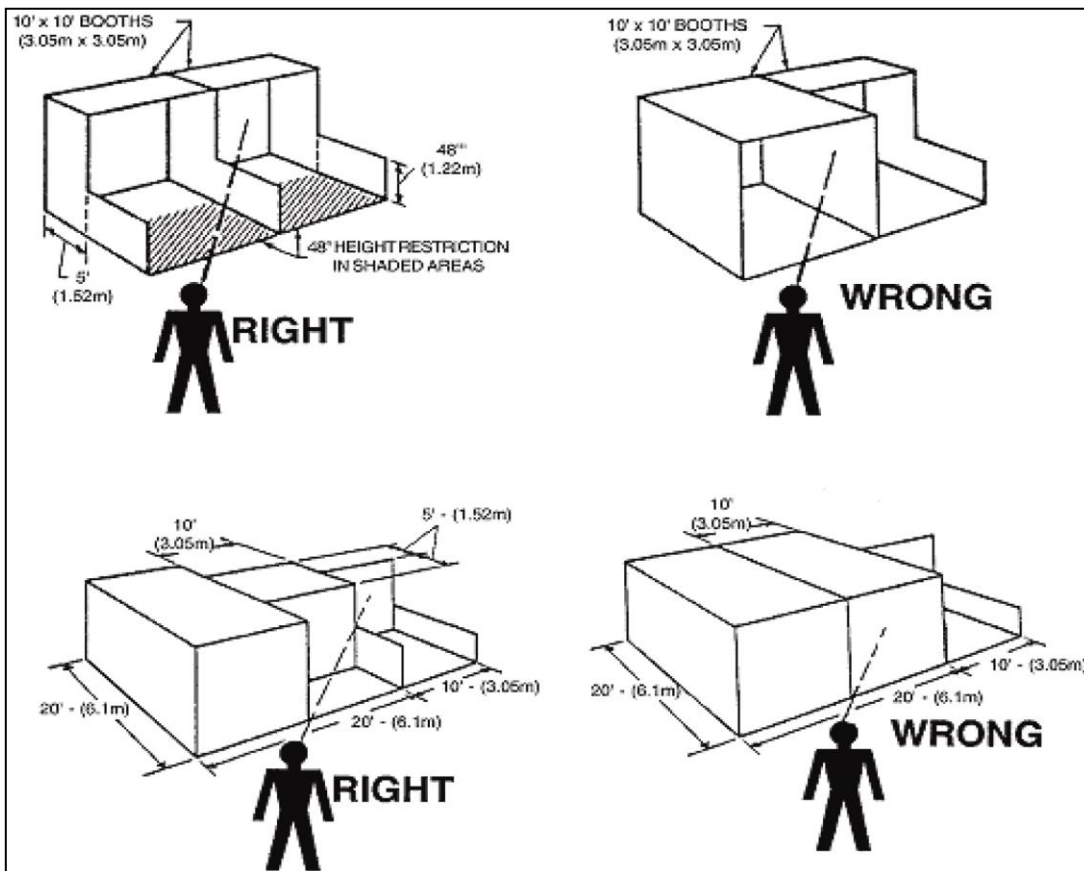



Union Jurisdictions

DELIVERY OF EXHIBITOR BOOTH MATERIALS

Exhibitors can deliver their own materials, (pop-up booth, give aways, literature, etc) to their booth space without the use of union personnel ***IF the materials can be carried by one company employee in trip without the use of any four wheeled dolly or bellman's cart. Bellman are not permitted on the event floor and if the use of a bell cart is used, each exhibitor will be charged the 200 lb minimum material handling fee based on the material handling worksheet located later on in this exhibitor manual.***

TEAMSTER UNION

Teamsters handle freight at the exhibit hall. Teamsters unload trucks or vehicles.

CARPENTER UNION

Carpenters handle the erection and dismantling of display and exhibit booths. This includes all display work as well as uncrating and re-crating machinery and equipment. Carpenters install and dismantle drapery, table skirting and floor coverings.

LABORER UNION

Laborers deliver freight to booths after it is unloaded by the Teamsters. Laborers deliver furniture and floor coverings, and assist Carpenters with erection and dismantling of exhibits and displays.

ELECTRICAL UNION

Electricians handle all electrical work, which includes applying supply power lines to your booth, connecting equipment to outlets and installing signs or banners that are lighted, unless they are permanently a part of the exhibit back wall.

WHAT CAN EXHIBITORS DO WITHOUT UNION PERSONNEL?

Exhibitors may install and dismantle their own exhibit and lay their own carpet in their own exhibit area as long as the following conditions are met:

- 1 The total booth size is 300 sq ft (10x30) or less.
- 2 No electric tools are used in the assembly or dismantle.
- 3 Individuals performing the work must be full time employees of the exhibiting company and carry identification to verify this fact.

Exhibitors can unpack and repack their own products in cartons, not crates. Exhibitors may "hand carry" or use nothing larger than a two wheeled baggage cart (rubber or plastic wheels only) to move items. Exhibitors may move a pop-up display, equal or less than 10' in length, if capable of being carried by hand, by one full time employee of the exhibiting company. Exhibitors can also do technical work on their own machines, such as balancing, programming, cleaning, etc.



Payment Policy

Show Site Orders: Services ordered at show site will require full payment at the time the order is placed. Purchase orders may not be used in lieu of payment. Regular prices will apply to all show site orders. Floor orders are limited to availability.

Third Party Orders: If you contract your work to a display or exhibit house and require services from Pinnacle, the payment policy stated above applies. Please pass this information along to them. A **Third Party Payment** form must be completed and submitted three weeks prior to show opening.

Charges: All charges, regardless of amount, must be paid in full by cash, check or credit card. If credit card method is used, please ensure that the card limits are high enough to cover your expected charges.

Past Due Accounts: The buyer understands that there will be a 1 1/2% monthly (18% per year) finance charge on past due accounts and agrees to pay all costs incurred by Pinnacle Exposition Services while seeking to collect this account.

Invoices: Within a week of the close of show, an invoice will be prepared and emailed for your review. Credits will be issued at show site only. If you have any questions, or would like to pay your invoice by check or cash, please see our customer service representatives at the service desk on site.

International Customers: International customers must pay for all services in U.S. funds. A \$50 service charge will be added for processing checks or wire transfers drawn on foreign banks.

U.S. Wire Transfers: A \$25 service charge will be added for processing U.S. wire transfers. Please complete the wire transfer portion of the **Payment Authorization Form**. The credit card portion of the form must still be completed before your order will be processed.

Tax Exempt Status: If you are tax exempt in the state where the show is held, a copy of the certificate must accompany your order.

Outbound Services: All outbound services will be processed on your credit card. A copy of the receipt and invoice will be mailed within 10 days of the close of the show.

Price Quotes: Prices quoted are for the duration of the show and include installation, rental, and removal, except where indicated.

Rental Responsibility: All materials are on a rental basis and shall remain the property of Pinnacle. The customer shall be held financially responsible for any damage to Pinnacle equipment used by the customer.

Claims for Loss and Payment of Services

Exhibitor agrees that any and all claims for loss or damage shall be submitted to Pinnacle within 30 days of the conclusion of the show. In the event that the alleged or suspected damage or loss occurred prior to show opening (i.e. during set up) or during the course of the show, it is imperative that you notify the onsite Pinnacle representative prior to the close of the show. For claim reporting purposes, the "conclusion" of the show shall be construed as the end of the day on which exhibitor must vacate the show site. All claims reported after the 30-day period will be rejected. In no event shall a suit or action be brought against Pinnacle more than one year after the date that loss or damage occurred. Payment for services may not be withheld. In the event of any dispute between Pinnacle and the exhibitor relative to any loss or damage claim, the exhibitor shall not be entitled to, and shall not withhold payment for Pinnacle services as an offset against the amount of the alleged loss or damage. Any claim against Pinnacle shall be considered a separate transaction and shall be resolved on its own merit.

Inbound and Outbound Shipments

Consistent with trade show industry practices, there may be a lapse of time between the delivery of shipment(s) to the booth and the arrival of the exhibitor or his representative. During such time, the materials will be left unattended. Pinnacle is not, and cannot be, responsible for loss, damage, theft, or disappearances of exhibitor's materials after same have been delivered to the exhibitor's booth. Similarly, there may be a lapse of time between the completion of packing and the actual pick up of exhibitor's materials from the booth for loading onto a carrier. During such time, the materials will be left unattended. Pinnacle shall not be responsible for loss, damage, theft, or disappearance of exhibitor's materials before same have been picked up for loading after the show. All materials will be checked at the booth at the time of loading using document(s) submitted by the exhibitor and notations of exceptions to conditions of materials, or piece counts will be made on said document. Pinnacle assumes no responsibility for loss, damage, theft, or disappearance of exhibitor's materials after same have been delivered to exhibitor's appointed carrier or agent for transportation.

Material Handling and Labor

Exhibitors are required to follow local labor jurisdictions. Most trade show labor is unionized, and therefore, Pinnacle is required to go through the local unions for labor used for show set up and dismantle. Drayage, or material handling, is the movement of show materials from the shipping dock to your booth for show set up and from your booth back to dock for return shipment at the end of the show.

Packaging Crates and Empty Containers

Pinnacle shall not be responsible for surface damage to loose or uncrated materials, pad-wrapped, or shrink-wrapped materials. Pinnacle shall not be responsible for concealed damage, damage to carpets in bags or poly, or damage to materials improperly packed. Pinnacle shall not be responsible for crates and packaging unsuitable for handling, partially assembled, or having prior damage. Affixing "Empty" storage labels to containers is the sole responsibility of the exhibitor or his representative. All previous labels should be removed. Pinnacle assumes no responsibility for removal or misdelivery of containers with old labels or incorrect information on labels or for loss or damage to materials stored in containers labeled "empty."



Discount Deadline: March 9

Payment Authorization

Please complete the information requested below and return this form with your orders. You may choose to pay by credit card, check payable to Pinnacle Exposition Services LLC, or bank wire transfer. However, we require your credit card authorization to be on file **before** we process your order(s) for service. We will use this authorization to charge your credit card account for any additional amounts incurred as a result of show site orders placed by your representative to include material handling charges for shipments received on your company's behalf and any unpaid balance due for Pinnacle's services. **Credits for services will be issued at show site only.**

Credit Card Information

Type of card:



Credit Card Number: _____

Expiration Date: _____ Security Code: _____
Month Year

Billing Address: _____

City, State, Zip: _____

Name on the card: _____

Authorized Signature: _____

Exhibiting Company Information

Please fill out the following information:

Company Name: _____ Booth Number: _____

Company Address: _____ Phone: _____

City, State, Zip: _____ Fax: _____

Contact Name: _____ Email: _____

Third Party Payment Information

Third-Party Payment: If you have arranged for an exhibit house to handle payment of your bill, the **Third-Party Payment** page of this order form must be completed. As the exhibitor, you are responsible for all charges incurred at the show should your display house fail to meet the required payment terms explained above. Please provide the information requested regarding the third party handling payment of your bill on the **Third Party Payment** form.



Discount Deadline: March 9

Exhibiting Company Authorization of Third Party Billing

In order for Pinnacle to invoice a third party for payment of services rendered to exhibitors, both the exhibiting company and the third party must complete this form and return at least 14 days prior to show move-in.

Services To Be Covered By Third Party

All services

Rental Furniture
Carpet
Material Handling
Other

Rental Displays
Cleaning
Labor

(if other please specify) _____

Third Party Information

Company Name: _____

Booth Number: _____

Company Address: _____

Phone: _____

City, State, Zip: _____

Fax: _____

Contact Name: _____

Email: _____

Authorized Signature: _____

Exhibiting Company Information

Company Name: _____

Booth Number: _____

Company Address: _____

Phone: _____

City, State, Zip: _____

Fax: _____

Contact Name: _____

Email: _____

Authorized Signature: _____

Credit Card Information

Type of card:



Credit Card Number: _____

Expiration Date: _____
Month Year

Security Code: _____

Billing Address: _____

City, State, Zip: _____

Name on the card: _____

Authorized Signature: _____

By signing this form, both parties agree and understand that the exhibiting firm is responsible for all charges. In the event that the named third party does not make payment by show close, Pinnacle will be paid by the exhibiting firm at show site. The show site invoice may or may not include any outbound services, such as additional material handling, rigging, and/or shipping charges.



Exhibitor Appointed Contractor

The following must be completed and returned to Pinnacle 14 days prior to event move-in date.

Name of Non-official contractor: _____

Contact Name: _____ Phone: _____

Address: _____ Fax: _____

Exhibitors Signature: _____ Date: _____

Exhibiting Company: _____ Booth #: _____

Original Certificates Only. PHOTOCOPIES OR FACSIMILES WILL NOT BE ACCEPTED

The contractor hired by the exhibitor must, by the deadline date, provide Pinnacle with a current Certificate of Insurance with minimum limits of \$500,000 property damage per occurrence, \$1,000,000 personal injury per occurrence, workers compensation aggregate coverage of \$1,000,000 per occurrence, and naming Pinnacle Exposition Services as additionally insured for the time period of the show (including move-in and move-out days).

If required, the non-official contractor must be able to provide evidence that it has current and applicable labor contracts and must comply with all labor agreements and jurisdictions. The non-official contractor must not jeopardize the production of the event by any act or practice that would lead to work stoppages, strikes or labor disputes.

Non-official contractor employees must wear approved identification badges at all times while in the work area. Badges will be issued at show site, to authorized representatives, when all requirements have been met.

The non-official contractor must have all business licenses, work permits and insurance required by state and city governments and Facility Management before beginning work, and shall provide Show Management with evidence of compliance.

The non-official contractor may not solicit business on the exhibit floor.

The non-official contractor must confine its operations to the exhibit area of its clients. No service desks, storage areas or other work facilities will be located anywhere in the facility. Show aisles and public areas are not part of the Exhibitor's booth space.

Standard Booth Packages

Basic Booth Package A

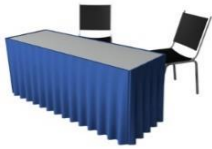

- 1 - 6'L x 30"H skirting table
- 2 - black padded side chairs
- 1 - waste basket

Discount	Standard	Quantity	Total
\$207.20	\$291.20		

Basic Booth Package B



- 1 - 42"H x 30'R pedestal table
- 2 - padded stools
- 1 - waste basket

Discount	Standard	Quantity	Total
\$220.00	\$288.80		

Premium Booth Packages

Premium Package A



- 1 - 6'L x 30"H skirting table
- 2 - black padded side chairs
- 1 - waste basket
- 1 - 10x10 or 8x10 carpet black*
- 200 lbs material handling

Discount	Standard	Quantity	Total
\$483.20	\$603.20		

*Carpet size based on event booth size

Premium Package B



- 1 - 42"H x 30'R pedestal table
- 2 - padded stools
- 1 - waste basket
- 1 - 10x10 or 8x10 carpet black*
- 200 lbs material handling

Discount	Standard	Quantity	Total
\$496.00	\$600.80		

*Carpet size based on event booth size

Premium Package C



- 1 - 6'L x 42"H skirting table
- 2 - padded stools
- 1 - waste basket
- 1 - 10x10 or 8x10 carpet black*
- 200 lbs material handling

Discount	Standard	Quantity	Total
\$531.20	\$667.20		

*Carpet size based on event booth size

Premium Package D



- 3 - full-color printed banners
- 1 - 6' skirting table
- 2 - black side chairs
- 200 lbs material handling

Discount	Standard	Quantity	Total
\$827.20	\$1,022.40		

Please select your table skirt color

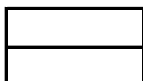

Black
Blue

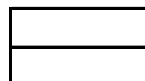

Green
Red

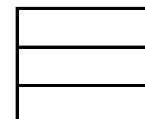

White
Burgandy
Grey

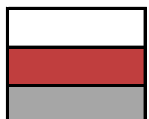

Platinum Booth Packages

Platinum Booth Package A



- 3 - 1 meter panel wall unit
- 1 - 30"R x 30"H cocktail table
- 4 - black padded side chairs
- 1 - waste basket
- 1 - 10x10 or 8x10 carpet black*
- 200 lbs material handling

Graphics not included, please see Graphics Order Form on page 16

Discount	Standard	Quantity	Total
\$1,250.00	\$1,550.00		

*Carpet size based on event booth size
Install and dismantle labor included

Platinum Booth Package B



- 10'W x 8'H x 18"D rental unit
- 1 - 6'L x 42"H black skirted table
- 2 - padded stools
- 1 - waste basket
- 1 - 10x10 or 8x10 carpet black*
- 200 lbs material handling

Graphics not included, please see Graphics Order Form on page 16

Discount	Standard	Quantity	Total
\$1,550.00	\$1,900.00		

*Carpet size based on event booth size
Install and dismantle labor included

Platinum Booth Package C



- 10'W x 8'T x 18"D rental unit
- 1 - 42"H x 18"D x 38"W counter
- 2 - padded stools
- 1 - waste basket
- 1 - 10x10 or 8x10 carpet black*
- 200 lbs material handling

Graphics not included, please see Graphics Order Form on page 16

Discount	Standard	Quantity	Total
\$1,750.00	\$2,100.00		

*Carpet size based on event booth size
Install and dismantle labor included

Platinum Booth Package D



- 3 - panel display size: 79.5" X 87"
- 2 - halogen lights
- 1 - 6' black skirted table
- 2 - side chairs

Graphics included

Discount	Standard	Quantity	Total
\$1,750.00	\$1,900.00		

Install and dismantle labor included

All prices include installation and dismantle labor on the rented booth
All graphics are ordered separately on the **Graphics Order Form**, page 16
All graphics files must be received as instructed in the **Artwork Guidelines Form**
For graphic information, please email our graphics department: graphics@pinnacle-expo.com

Grand Total

--

Posh Booth Packages

Posh Package A

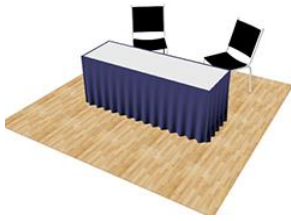

- 1 - 6'L x 30"H skirted table
- 2 - black padded side chairs
- 1 - waste basket
- 1 - 10x10 or 8x10 upscale flooring option*
- 200 lbs material handling

Discount	Standard	Quantity	Total
\$550.00	\$750.00		

*flooring option must be selected from option below

Posh Package B



- 3 - custom printed banner stands
- 1 - 6'L x 30"H skirted table
- 2 - black padded side chairs
- 1 - waste basket
- 1 - 10x10 or 8x10 upscale flooring option*
- 200 lbs material handling

Discount	Standard	Quantity	Total
\$895.00	\$1,100.00		

*flooring option must be selected from option below

Posh Package C

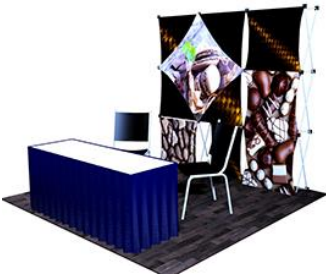

- 1 - GeoMetrix Pop Up
- 1 - 6'L x 30"H skirted table
- 2 - black padded side chairs
- 1 - waste basket
- 1 - 10x10 or 8x10 upscale flooring option*
- 200 lbs material handling
- *Graphics are included**

Discount	Standard	Quantity	Total
\$1,295.00	\$1,495.00		

*flooring option must be selected from option below

Please select your upscale flooring option



Black Wood

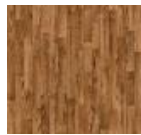

Cherry

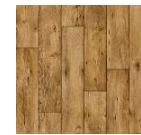

Maze



Antique Maple



Slate Stone

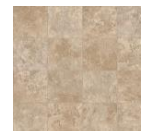

Sand

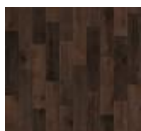

Burnt Wood

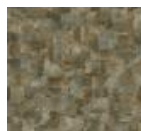

Contemporary

Please select your table skirt color

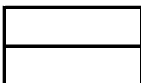

Black
Blue

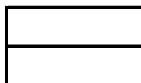

Green
Red



White
Burgandy
Grey

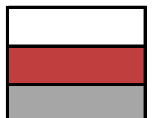

Rental Booths

Rental Booth A



- 7 - Custom Printed Graphic Panels
- 1 - 6' black skirted table
- 2 - side chairs

The excitement of three dimensions. Interchangeable, dye-sublimated fabric banners create a multitude of looks on one display.

Discount	Standard	Quantity	Total
\$925.00	\$1,250.00		

Install and dismantle labor included

Rental Booth B



- 9 - Custom Printed Graphic Panels
- 1 - 6' black skirted table
- 2 - side chairs

The excitement of three dimensions. Interchangeable, dye-sublimated fabric banners create a multitude of looks on one display.

Discount	Standard	Quantity	Total
\$925.00	\$1,350.00		

Install and dismantle labor included

Rental Booth C

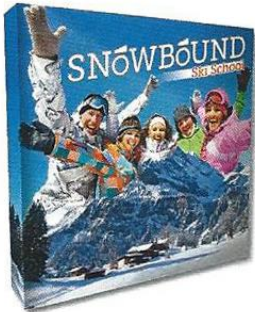

- 1- Straight End Wrapped Graphic
- 1 - 6' black skirted table
- 2 - side chairs

Communicate your message with a Splash. A full-color dye-sublimated fabric display.

Large seamless high resolution graphics on premium, poly knit fabric

Discount	Standard	Quantity	Total
\$1,250.00	\$1,750.00		

Install and dismantle labor included

Rental Booth D



- 3 - Mural Center Panels
- 2 - Mural End Panels
- Oval Graphic Wrap
- 1 - 6' black skirted table
- 2 - side chairs

A solid, traditional message with a classic look!

Discount	Standard	Quantity	Total
\$1,750.00	\$2,150.00		

Install and dismantle labor included



Carpet and Cleaning Services

To calculate your carpet, padding, and visqueen costs, please use the formula of booth dimension x booth dimension equals square footage

Standard Expo Carpet (16oz)

Example

$$\begin{array}{ccccccccc}
 \boxed{10} & & \boxed{10} & = & \boxed{100} & & \boxed{\$1.55} & = & \boxed{\$155.00} \\
 \text{Length} & \times & \text{Width} & & \text{Sq ft} & \times & \text{\$/sq ft} & & \text{Total cost}
 \end{array}$$

Your booth space

$$\begin{array}{ccccccccc}
 \boxed{} & & \boxed{} & = & \boxed{} & & \boxed{} & = & \boxed{} \\
 \text{Length} & \times & \text{Width} & & \text{Sq ft} & \times & \text{\$/sq ft} & & \text{Total cost}
 \end{array}$$

Please select your carpet color choice:



Black



Grey



Blue



Green



Burgandy



Red

Qty	Discount	Standard	Total
	\$1.55	\$2.00	

Please Note: All carpets are delivered clean, however during set up carpets may become dirty. We suggest a minimal one time prior to show opening cleaning to ensure you are looking your best. See below to order cleaning services.

Booth Padding and Visqueen (Visqueen is a temporary plastic covering to protect your carpet during set up)

To calculate padding and visqueen costs, please use square footage totals from above

Padding	Qty	Discount	Standard	Total
		\$0.90	\$1.10	

Visqueen	Qty	Discount	Standard	Total
		\$0.25	\$0.40	

Booth Cleaning

To calculate booth cleaning costs, please use square footage totals from above

One time pre show cleaning

Sq Ft	Discount	Standard	Total
	\$0.37	\$0.50	

Daily Vacuuming

Sq Ft	Discount	Standard	# of Days	Total
	\$0.45	\$0.60		

Please Note: All carpets are delivered clean, however during set up carpets may become dirty. We suggest a minimal one time prior to show opening cleaning to ensure you are looking your best.

Carpet, Padding, and Cleaning Totals



Upscale Flooring Options

To calculate your flooring costs, please use the formula of booth dimension x booth dimension equals square footage

Basic Vinyl Flooring

Example

$$\begin{array}{ccccccccc}
 \boxed{10} & & \boxed{10} & = & \boxed{100} & & \boxed{\$2.75} & = & \boxed{\$275.00} \\
 \text{Length} & \times & \text{Width} & & \text{Sq ft} & \times & \text{\$/sq ft} & & \text{Totalcost}
 \end{array}$$

Your booth space

$$\begin{array}{ccccccccc}
 \boxed{} & & \boxed{} & = & \boxed{} & & \boxed{} & = & \boxed{} \\
 \text{Length} & \times & \text{Width} & & \text{Sq ft} & \times & \text{\$/sq ft} & & \text{Total cost}
 \end{array}$$

Please select your basic flooring choice:

Balsa	British Wood	Georgia	Scarlet	Washington
 <input type="checkbox"/>	 <input type="checkbox"/>	 <input type="checkbox"/>	 <input type="checkbox"/>	 <input type="checkbox"/>

Qty	Discount	Standard	Total
	\$2.75	\$4.00	

Exotic Vinyl Flooring

Antique Maple	Natural Oak	Burnt Wood	Maze
 <input type="checkbox"/>	 <input type="checkbox"/>	 <input type="checkbox"/>	 <input type="checkbox"/>
Black Wood	Cherry	Maple	
 <input type="checkbox"/>	 <input type="checkbox"/>	 <input type="checkbox"/>	
Slate Stone	Light Slate	Urban Wood	
 <input type="checkbox"/>	 <input type="checkbox"/>	 <input type="checkbox"/>	
Sand	Contemporary		
 <input type="checkbox"/>	 <input type="checkbox"/>		

Qty	Discount	Standard	Total
	\$3.00	\$4.50	

Booth Furnishings

All prices include delivery to and from the booth and are a "per show" cost, not a daily rental

Skirted Tables (select color below, right)

30" High	Discount	Standard	Qty
4' x 2'	\$114.00	\$155.00	
6' x 2'	\$124.00	\$168.00	
8' x 2'	\$149.00	\$199.00	



42" High	Discount	Standard	Qty
4' x 2'	\$138.00	\$186.00	
6' x 2'	\$149.00	\$198.00	
8' x 2'	\$174.00	\$230.00	

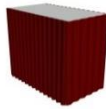

Unskirted Tables

30" High	Discount	Standard	Qty
4' x 2'	\$55.00	\$72.00	
6' x 2'	\$60.00	\$78.00	
8' x 2'	\$65.00	\$83.00	



42" High	Discount	Standard	Qty
4' x 2'	\$72.00	\$90.00	
6' x 2'	\$76.00	\$96.00	
8' x 2'	\$80.00	\$101.00	



Fourth Side Draping

Covers the open side of the table

30" High	Discount	Standard	Qty
4th side	\$56.00	\$72.00	

42" High	Discount	Standard	Qty
4th side	\$72.00	\$94.00	

Round Tables

Tables come draped in black

30" High	Discount	Standard	Qty
	\$70.00	\$95.00	

42" High	Discount	Standard	Qty
	\$90.00	\$115.00	



Seating



black padded side chair

Discount	Standard	Qty
\$60.00	\$85.00	



black padded arm chair

Discount	Standard	Qty
\$76.00	\$95.00	



padded stool

Discount	Standard	Qty
\$85.00	\$110.00	

Specialty Items

Curved Cabinet

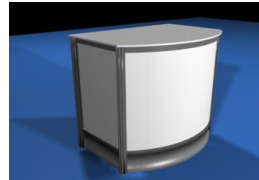

42"H x 38"W x 26"D

Discount	Standard	Qty
\$395.00	\$475.00	

Black White

Rectangular Counter

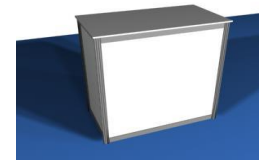

42"H x 38"W x 20"D

Discount	Standard	Qty
\$295.00	\$350.00	

Black White

Please Select Your Table Skirt Color

Black		<input type="checkbox"/>
Blue		<input type="checkbox"/>
Green		<input type="checkbox"/>
Red		<input type="checkbox"/>
White		<input type="checkbox"/>
Burgandy		<input type="checkbox"/>
Grey		<input type="checkbox"/>

Total for Booth Furnishings

Floral and Booth Accessories

Plant and Floral Arrangements

Qty	Description	Discount	Standard	Total
	2' - 3' greens (typically a fern or similar)	\$90.00	\$110.00	
	4' - 5' greens (typically a Ficus or similar)	\$120.00	\$140.00	
	seasonal arrangement	\$95.00	\$115.00	
	seasonal arrangement upgraded	\$140.00	\$165.00	
	tropical flowers	\$145.00	\$175.00	
	roses	\$110.00	\$125.00	

Pictures below are examples only of items ordered



Fern



Ficus



Seasonal



Seasonal Upgraded



Tropical



Roses

Booth Accessory Items



Waste Basket



Chrome Easel



Fish Bowl



Bag Rack



Literature Stand

Qty	Description	Discount	Standard	Total
	waste basket	\$15.00	\$26.00	
	chrome easel	\$40.00	\$55.00	
	fish bowl	\$25.00	\$40.00	
	bag rack	\$175.00	\$225.00	
	literature stand	\$135.00	\$175.00	

Floral and Accessory Totals



Discount Deadline: March 9

Booth Labor (1 hour minimum per worker)

			Discount	Standard
Straight time:	8:00 am - 4:30 pm	Monday through Friday	\$140.00	\$140.00
Overtime:	4:30 pm - 8:00 am	Monday through Friday	\$210.00	\$210.00
	All Day	Saturday and Sunday		
Double time:	All times not mentioned above, as well as Holidays		\$280.00	\$280.00

Show site orders will apply to all orders placed at the service desk on site

- * Start time is only guaranteed at start of the work day
- * One hour minimum per person
- * Supervisor or Exhibitor must check in at the service desk to pick up labor
- * Labor must be cancelled in writing, 24 hours in advance to avoid a one (1) hour cancellation fee per worker
- * When scheduling dismantle labor, please ensure you allow enough time for your empties to be returned to your booth

Installation Labor

Pinnacle Supervised Installation Labor - Please fill out page 14 for important set up information

- Installation of your exhibit will be completed at our discretion prior to the show opening
- The charge for this service is 30% of the total installation labor bill

Onsite Contact Name: _____ Phone Number: _____

Exhibitor Supervised Installation Labor-

Supervisor onsite will be: _____ Phone Number: _____

Date	Start Time	Number of People	Approx Hours		Total Hours		Hourly Rate	Estimated Total Cost	
				x		x	\$		
				x		x	\$		
				x		x	\$		
								Pinnacle Installation (+30%)	

Dismantle Labor

Pinnacle Supervised Dismantle Labor - Please fill out page 14 for important dismantle information

- Pinnacle is not responsible for product or literature not properly packed and labeled by the exhibitor
- The charge for this service is 30% of the total dismantle labor bill

Onsite Contact Name: _____ Phone Number: _____

Exhibitor Supervised Dismantle Labor-

Supervisor onsite will be: _____ Phone Number: _____

Date	Start Time	Number of People	Approx Hours		Total Hours		Hourly Rate	Estimated Total Cost	
				x		x	\$		
				x		x	\$		
				x		x	\$		
								Pinnacle Dismantle (+30%)	

Total Installation and Dismantle Labor



Pinnacle Supervised Labor information Sheet

Please complete this form if you have chosen Pinnacle Supervised installation or dismantle.

For Installation

Inbound Freight Information

Carrier Company Name _____

Tracking Number _____

Number of Pieces _____

Estimated Arrival Date _____

Is Shipment: Crated Uncrated

Weight of Shipment _____

Shipment to arrive at Warehouse Show

Booth Size: x

Fork lift required? Yes No

Carpet is: Owned Rented from Pinnacle

Carpet Padding Yes No

For Dismantle

Outbound Freight Information

Carrier Name _____ Phone _____

Deliver Shipment to _____

Address _____

City _____ State _____ Zip _____

Types of Service Air Van Line Fed Ex/DHL/UPS

If for any reason your shipment is not picked up by your specified carrier, would you like Pinnacle to:

Redirect your materials via the house carrier Send shipment back to Pinnacle warehouse*

*there is a \$150 service fee for this option

Services you have ordered

- Electrical* Furniture Audio Visual Equipment
- Booth Cleaning Telephone/Internet Other _____

*Please provide electrical order information

- Electric should go under the carpet (diagram attached)
- Electrical drawings are attached
- Electrical drawings are in crate number



Artwork Guidelines

Our desire is to provide our clients with the best possible quality graphics for your event, booth, or function. You can help us out in this effort by providing us your digital artwork according to the guidelines listed below.

Please provide the following when submitting your artwork to us

Minimum requirements for original artwork, such as logos, when Pinnacle is providing design layout:

- * 300 dpi resolution at a size of 8x10 inches

Minimum requirements for final artwork that Pinnacle will reproduce exactly as provided:

- *300 dpi at 1/4 scale of actual size

Minimum requirements for both:

- * All PMS and/or CMYK color codes
- * Accurate color proof of finished artwork
- * Contact name and number of artwork creator (if possible)
- * Please embed all fonts and convert all text to curves or outlines

Acceptable File Software Formats

- * ADOBE - Illustrator, InDesign, and Photoshop
- * COREL DRAW
- * Print ready ADOBE PDF's

Files should always be saved in their native format

Acceptable File Types

Files that Pinnacle can use in order of preference are:

- *EPS and AI (especially helpful with logos)
- *TIF (especially when submitting photos)
- *JPG (needs to be very high resolution, copy and pasted web images are unacceptable)

Files that Pinnacle cannot use to product high level quality graphics are:

- *GIF files
- *Microsoft Office software such as Word, Excel, Powerpoint, etc

Ways To Send Pinnacle Your Artwork Files

Files can be uploaded to our FTP site. Please contact our graphics department, graphics@pinnacle-expo.com, for log-in information in order to port files to Pinnacle's FTP site. Please call 855-451-6893 with any other questions.



Graphics Order Form

Digital Graphics

Pinnacle can produce four color, photo quality, high resolution digital printing in virtually any size banner, sign, exhibit graphics and more.

_____ L x _____ W = _____ sq ft x \$14.00 \$ _____

*14.00 per sq ft (standard rate is \$20.00)

*Double sq ft for double sided signs

*Round sq ft to next highest whole increment

For large digital graphics please email our graphics department at graphics@pinnacle-expo.com for quotes on graphics over 80 sq ft

Standard Sizes

Qty	Description	Discount	Standard	Amount
	Vertical 22"x28"	\$90.00	\$120.00	
	Horizontal 22"x28"	\$90.00	\$120.00	
	Vertical 28"x44"	\$125.00	\$160.00	
	Horizontal 28"x44"	\$125.00	\$160.00	
	Meter Board 38" x 87"	\$395.00	\$495.00	

Vertical

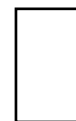

Horizontal



Graphics for Any of the Platinum Booth Packages

For all Platinum Booth Packages:

*each package is made with three (3) 38 1/8" x 87" graphic panels

*because of the package, we offer the three panels at \$195 (up to the discount deadline)

*please follow artwork submission guidelines on previous page

Select your Platinum Package:

- A
- B
- C
- D

Qty	Description	Discount	Standard	Total
		\$195.00	\$295.00	
		\$195.00	\$295.00	
		\$195.00	\$295.00	
	Graphics Included In Package D			

Platinum Packages B and C also come with a 10" x 144" header at no cost

Would you like the included header? Yes No

If yes, please write your header copy here: _____

If you would like a digitally printed header, follow the Artwork Submission Guidelines on the previous page

If you do not require full panel graphics, please select the velcro-friendly panel color you would like to have installed

- Black
- Gray
- Blue

then select your graphic sizes above and follow the Artwork Guidelines on the previous page for submission of artwork.

Total for Graphics Order Form



Poster Printing Request Form

We at Pinnacle understand the inconvenience of having to go and get your poster printed, coordinate the shipping both to and from the event, taking it on the plane or checking it in as luggage.

Let us take the worry out of all of that, and relieve the stress of wondering if your poster is going to be delivered to your event on time.



With Pinnacle's Poster Printing Service, we will print your poster on your choice of plain paper, or an upgraded heavy-duty paper, and will have it sitting at the registration area when you arrive at the conference to pick up your event credentials. For a small additional fee, we will hang the poster in your designated poster location, so everything is in place and ready for your arrival.

Poster size 4'x4' (actual size 46" x 46")

Qty	Paper Type	Discount	Standard
	Plain	\$65.00	\$85.00
	Upgraded	\$90.00	\$110.00

Total

Poster size 4'x8' (actual size 46" x 92")

Qty	Paper Type	Discount	Standard
	Plain	\$100.00	\$125.00
	Upgraded	\$125.00	\$150.00

Total

Note: Poster sizes are determined by show management

Please provide the following information so that we can ensure your poster is labeled correctly for your pick up at registration.

Company Name: _____

Poster Number: _____

Dates and times your poster is to be presented: _____

Onsite contact (person picking up the poster at registration) _____

Please refer to the "Artwork Guidelines" page for format of artwork and ways to submit your artwork to Pinnacle

To have Pinnacle hang your poster in its designated space, please add \$25

Poster Printing Services Total



Discount Deadline: March 9

Request for Pre-Printed Outbound Shipping Labels and Bill of Lading

BOOTH #

We will gladly prepare your **Outbound Material Handling Agreement** and labels and return them to your booth prior to show close. To take advantage of this service please complete the bottom of this form.

Once your materials are packed and ready to be shipped, please return the Material Handling Agreement to your Pinnacle Expo Services Representative.

Pinnacle Expo will make arrangements for all Pinnacle Expo Services House Carrier Shipments. **Arrangements for pick-up by other carriers is the responsibility of the exhibitor.** During Exhibitor move out, if time permits, Pinnacle will attempt a courtesy phone call to your carrier to confirm scheduled pick-up.

Ship To Address:

Company Name: _____

Delivery Address: _____

City: _____ State: _____ Zip: _____

Contact Name: _____ Booth # (if going to another event) _____

Number of Labels Requested: _____

Carrier Selection:

Official Show Carrier: Cargo Solutions

Other: _____

** If selecting a carrier other than the house carrier, it is the exhibitors responsibility to coordinate pick up

Transportation Billing Address: Please let us know who is responsible for covering the costs of shipping your materials to the above location, in the event Pinnacle Expo receives and invoice from your designated carrier.

Company Name: _____ Same as Ship To Address

Delivery Address: _____

City: _____ State: _____ Zip: _____

Outbound Shipping Notes:

- * Pinnacle will deliver your pre-filled Bill of Lading and labels to your booth, prior to show closing
- * Completed Bill of Lading must be returned to the Pinnacle Service Desk PRIOR to exhibitor leaving
- * Exhibitors must ensure all of their packages are sealed, secured and labeled as per the Bill of Lading
- * Multiple shipping destinations require multiple Bills of Lading
- **** If you are shipping UPS/Fed Ex, the exhibitor is required to provide their own labels****



Discount Deadline: March 9

Advanced Warehouse Shipping Labels

R U S H	 C/O Cargo Solutions-Eagle Trucking 900 CALCON HOOK RD SHARON HILL, PA 19079 Population Health Colloquium & Medical Home Summit	A d v a n c e d	Forerunner Events
	Company Name:		
	Booth Number Number of Pieces:		

R U S H	 C/O Cargo Solutions-Eagle Trucking 900 CALCON HOOK RD SHARON HILL, PA 19079 Population Health Colloquium & Medical Home Summit	A d v a n c e d	Forerunner Events
	Company Name:		
	Booth Number Number of Pieces:		

Advanced Warehousing Dates

Advanced warehouse opens: Monday, March 9 8:00 am-3:00 pm daily

Advanced warehouse closes: Thursday, March 19 8:00 am-3:00 pm daily



Discount Deadline: March 9

Direct to Showsite Shipping Labels

R U S H	 C/O Loews Hotel Philadelphia 1200 Market Street Philadelphia, PA 19107 Population Health Colloquium & Medical Home Summit Monday, March 23 Between 8:00 am - 10:00 am	S H O W	Forerunner Events
	Company Name:		
	Booth Number		Number of Pieces:

R U S H	 C/O Loews Hotel Philadelphia 1200 Market Street Philadelphia, PA 19107 Population Health Colloquium & Medical Home Summit Monday, March 23 Between 8:00 am - 10:00 am	S H O W	Forerunner Events
	Company Name:		
	Booth Number		Number of Pieces:

Direct to Showsite Shipping Information

Show site delivery timeframe:

Monday, March 23

Between 8:00 am - 10:00 am



All exhibitors must complete the **Order Recap Form** to ensure all services are paid in full prior to event.

Order Recap Form

Please complete and return this form along with all completed applicable order forms, plus payment in full

Booth Number:
Company Name:
Address:
City:
State:
Zip:
Contact Name:
Phone:
We at Pinnacle want to thank you for exhibiting and we understand the trials and tribulations of getting things processed for an event. Please feel free to send us your positive and negative feedback at customerservice@pinnacle-expo.com

Standard and Premium Packages Form *

Platinum Packages Form *

Rental Booth Order Form *

Carpet, Padding, and Cleaning Services Form *

Upscale Flooring Order Form *

Booth Furnishings Order Form *

Floral and Booth Accessories Form *

Installation and Dismantle Labor Form *

Graphics Order Form *

Material Handling Rates and WorkSheet *

Poster Printing Services Form *

Payment Authorization Form Attached Yes/No

Total:

8% PA Sales Tax:

***denotes taxable items**

Grand Total Due Pinnacle

Payment Method: When paying via credit card, please ensure you have included the **Method of Payment form.**

Visa

Mastercard

American Express

PAYMENT POLICY:

Payment in full of rental charges including applicable tax must accompany advance order and must be received by the Deadline Date in order to qualify for discount rates. All orders placed at the service desk will be charged at standard rates. All balances must be settled at the Service desk prior to Show closing. All charges are payable in U.S. Funds only. Check, Cash, Traveler's Checks, Visa, MasterCard and American Express are

All charges subject to MA Sales Tax (6.25 %). Full payment must accompany the Order Recap Form which lists all items ordered.

CANCELLATION POLICY: Items canceled after the deadline date will receive a 50% discount. No refunds will be given on cancelled items after set up.

Please select how you would like your order confirmed:

Phone

Fax

email